

# Trimless recessed luminaire



Tetro A25 32W 830 IP44/20

ze11009646



220-240 V



IP44

Ra >80

MAC 3

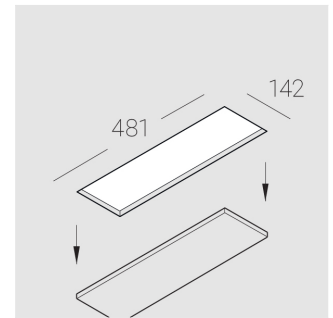
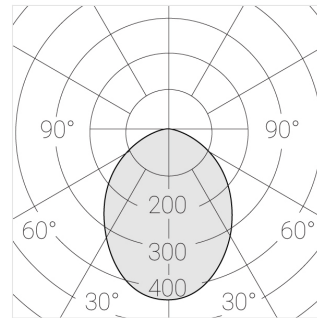
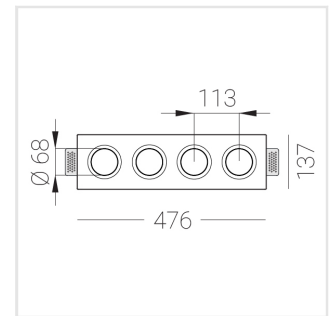
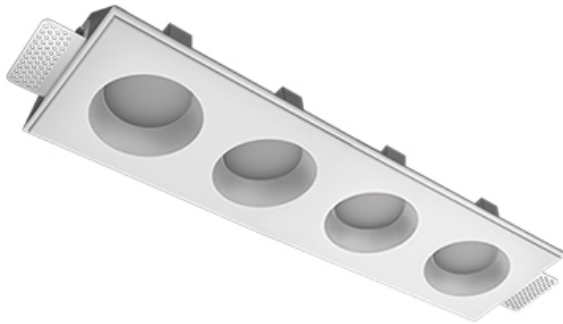

## Complectation

Body	1
LED module	4
Control gear	4
Fastener	2
Screw x6	4
Screw self-tapping	2
Washer D5	4
Suction Cup	1

Dimming by TRIAC accessible on request

The manufacturer reserves the right to change the configuration of the LED luminaire.

## Specifications

Measurements:	475x137x70 mm
Net weight:	2.48 kg
Quadruple	
Body:	Gypsum
Illuminant:	LED
Electrical safety class:	II
Degree of protection:	IP44
Rated power:	31.2 W
Luminaire luminous flux*:	2556 lm
Light output*:	82 lm/W
Colorful temperature*:	3000 K
Color rendering index*:	Ra >80
Color temperature stability*:	MAC 3
cos *:	0.4
PRA:	Mean Well APC-8-250

All parameters marked with \* are calculated values. Zenith uses tried and tested components from leading suppliers. However, it is possible for some LED technology-related faults to occur over the life of the product.

\*\* — the manufacturer reserves the right to replace the power supply with a similar one with the same characteristics.