

Trimless recessed luminaire



Tetro A25 44W 840 IP44/20 DA
ze11009862



220-240 V



IP44

Ra >80

MAC 3

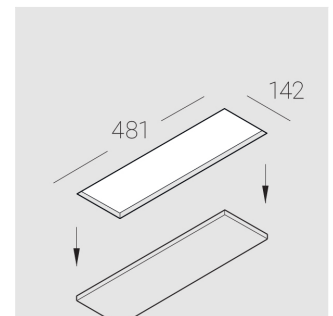
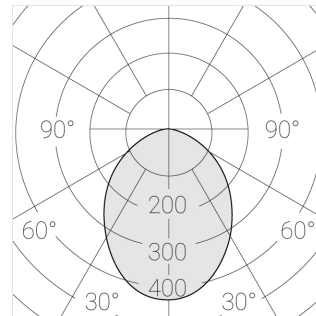
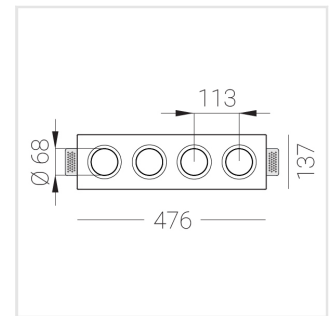
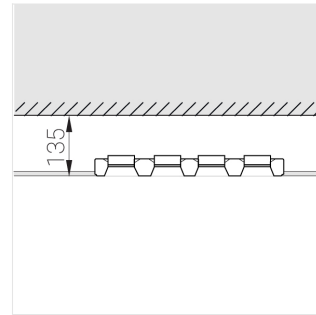
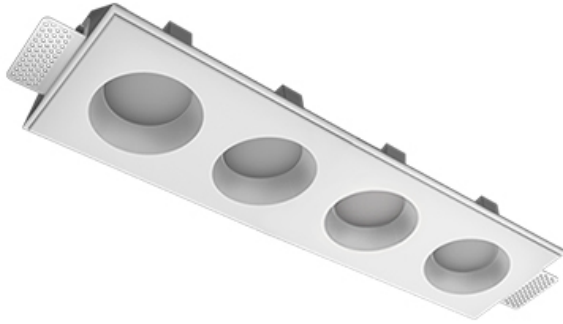

Complectation

Body	1
LED module	4
Control gear	1
Fastener	2
Screw x6	4
Screw self-tapping	2
Washer D5	4
Suction Cup	1

Dimming by TRIAC accessible on request

The manufacturer reserves the right to change the configuration of the LED luminaire.

Specifications

Measurements:	475x137x70 mm
Net weight:	2.45 kg
Quadruple	
Body:	Gypsum
Illuminant:	LED
Electrical safety class:	II
Degree of protection:	IP44
Rated power:	41.5 W
Luminaire luminous flux*:	3770 lm
Light output*:	91 lm/W
Colorful temperature*:	4000 K
Color rendering index*:	Ra >80
Color temperature stability*:	MAC 3
cos *:	0.97
PRA:	LCA 45W 500-1400mA one4all SC PRE

All parameters marked with * are calculated values.
Zenith uses tried and tested components from leading suppliers.
However, it is possible for some LED technology-related faults to occur over the life of the product.

** — the manufacturer reserves the right to replace the power supply with a similar one with the same characteristics.