

Large-size trimless recessed luminaire



Simple MAX R50 D400 64W 927

ze11009053



220-240 V



IP20

Ra >90

MAC 3

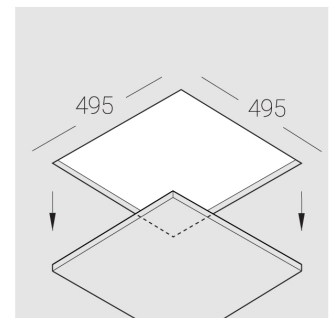
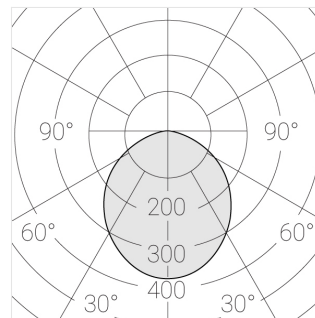
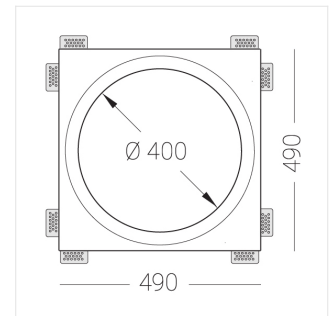
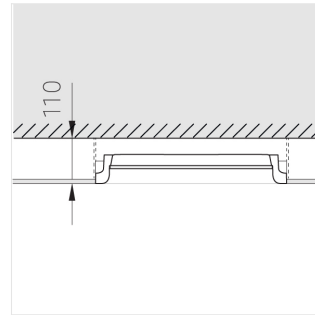

Complectation

Body	1
LED module	1
Control gear	1
Fastener	8
Screw x6	16
Screw self-tapping	16
Washer D5	20
Suction Cup	2
Bracket	4
Screw M5x8	4

Dimming by TRIAC accessible on request

The manufacturer reserves the right to change the configuration of the LED luminaire.

Specifications

Measurements:	490x490x110 mm
Net weight:	9.17 kg
Round	
Body:	Gypsum
Illuminant:	LED
Electrical safety class:	II
Degree of protection:	IP20
Rated power:	63.7 W
Luminaire luminous flux*:	5443 lm
Light output*:	85.00 lm/W
Colorful temperature*:	2700 K
Color rendering index*:	Ra >90
Color temperature stability*:	MAC 3
cos *:	0.97
PRA:	LC 60W 900-1750mA flexC SR EXC

All parameters marked with * are calculated values. Zenith uses tried and tested components from leading suppliers. However, it is possible for some LED technology-related faults to occur over the life of the product.

** — the manufacturer reserves the right to replace the power supply with a similar one with the same characteristics.