

Suspension luminaire



Orby Cu RAL 8W 940

ze34001215

EAC

220-240 V



IP20

Ra >90

MAC 3

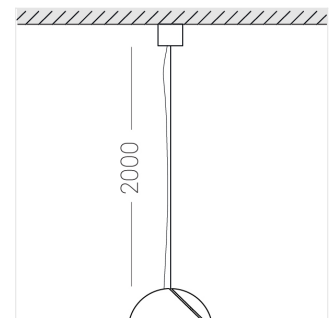
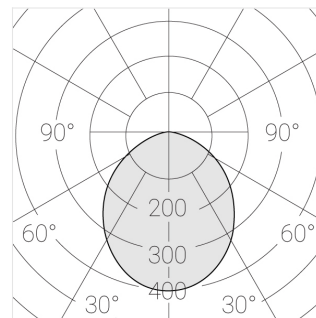
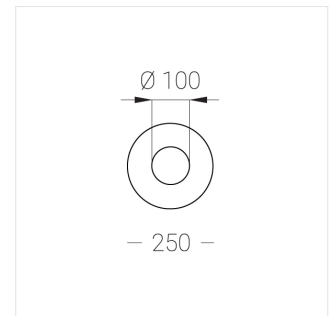
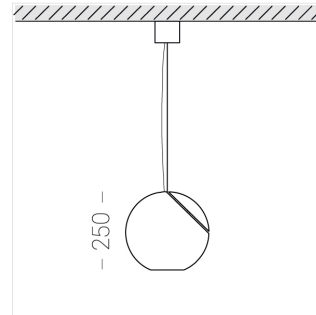
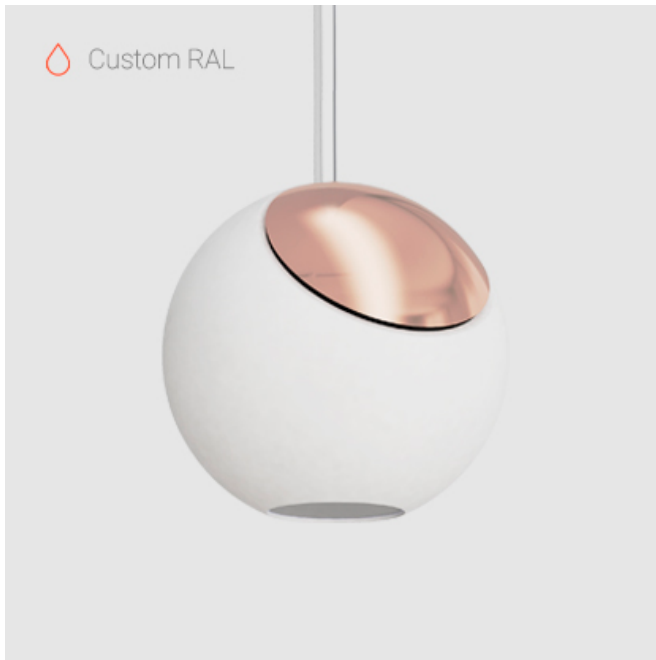

Complectation

Body	1
LED module	1
Control gear	1
Ceiling attachment	1
Suspension cord	1
Cable	1
Metal cup	1

Dimming by TRIAC accessible on request

The manufacturer reserves the right to change the configuration of the LED luminaire.

Specifications

Measurements:	D250; D78x65 mm
Net weight:	3.84 kg

Sphere	
Body:	Gypsum
Illuminant:	LED

Electrical safety class:	I
Degree of protection:	IP20
Rated power:	8 W
Luminaire luminous flux*:	797 lm
Light output*:	100.00 lm/w
Colorful temperature*:	4000 K
Color rendering index*:	Ra >90
Color temperature stability*:	MAC 3
cos *:	0.5
PRA:	LC 8/180/44 fixC SC SNC2

All parameters marked with * are calculated values.
Zenith uses tried and tested components from leading suppliers.
However, it is possible for some LED technology-related faults to occur over the life of the product.

** — the manufacturer reserves the right to replace the power supply with a similar one with the same characteristics.