

Trimless recessed luminaire

Zenit

Tetro A25 44W 930 IP44/20

ze11009689



220-240 V



IP44

Ra >90

MAC 3

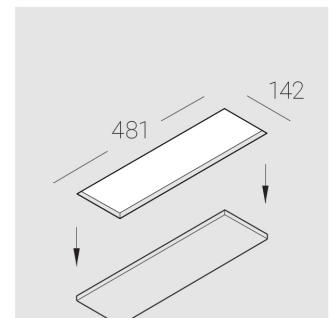
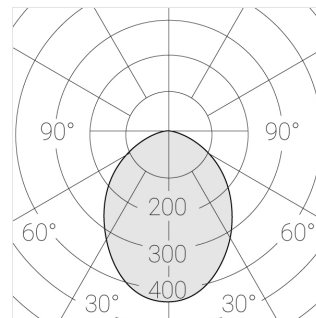
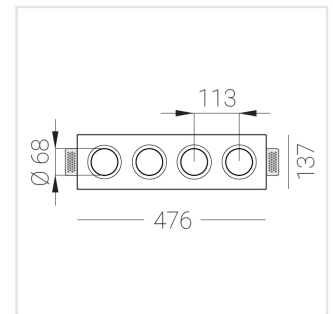

Complectation

Body	1
LED module	4
Control gear	4
Fastener	2
Screw x6	4
Screw self-tapping	2
Washer D5	4
Suction Cup	1

Dimming by TRIAC accessible on request

The manufacturer reserves the right to change the configuration of the LED luminaire.

Specifications

Measurements:	475x137x70 mm
Net weight:	2.6 kg
Quadruple	
Body:	Gypsum
Illuminant:	LED
Electrical safety class:	II
Degree of protection:	IP44
Rated power:	44.8 W
Luminaire luminous flux*:	3017 lm
Light output*:	67.00 lm/w
Colorful temperature*:	3000 K
Color rendering index*:	Ra >90
Color temperature stability*:	MAC 3
cos *:	0.5
PRA:	Mean Well APC-12-350

All parameters marked with * are calculated values. Zenith uses tried and tested components from leading suppliers. However, it is possible for some LED technology-related faults to occur over the life of the product.

** — the manufacturer reserves the right to replace the power supply with a similar one with the same characteristics.