

# Suspension luminaire

Zenit

Orby Cu RAL 8W 930

ze34001214

EAC 220-240 V  IP20 Ra >90 MAC 3

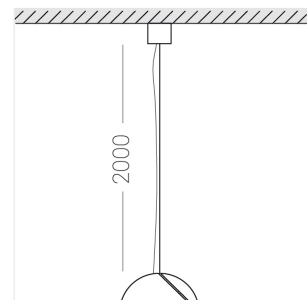
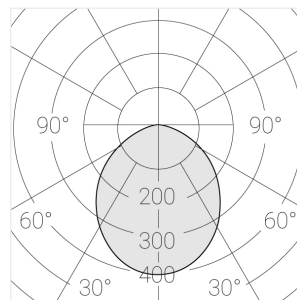
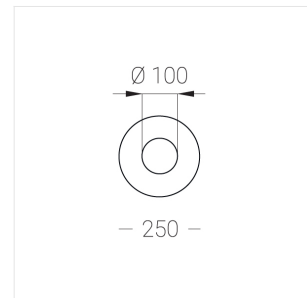
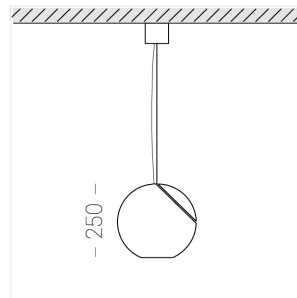
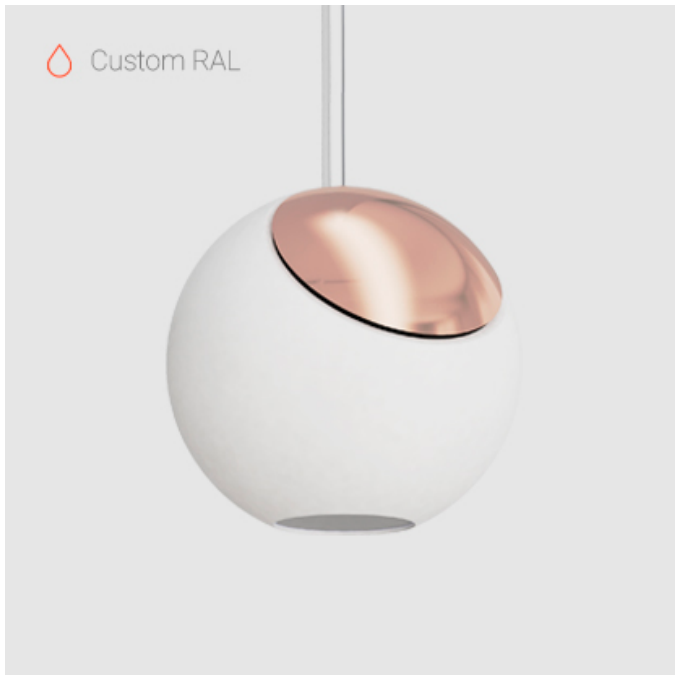

## Complectation

Body	1
LED module	1
Control gear	1
Ceiling attachment	1
Suspension cord	1
Cable	1
Metal cup	1

Dimming by TRIAC accessible on request

## Specifications

Measurements:	D250; D78x65 mm
Net weight:	3.84 kg
Sphere	
Body:	Gypsum
Illuminant:	LED
Electrical safety class:	I
Degree of protection:	IP20
Rated power:	8 w
Luminaire luminous flux*:	739 lm
Light output*:	92 lm/w
Colorful temperature*:	3000 K
Color rendering index*:	Ra >90
Color temperature stability*:	MAC 3
cos *:	0.5
PRA:	LC 8/180/44 fixC SC SNC2

All parameters marked with \* are calculated values. Zenith uses tried and tested components from leading suppliers. However, it is possible for some LED technology-related faults to occur over the life of the product.