

Trimless recessed luminaire

Simple Quadro A56 100x100 9W 940 DA
ze11009140



EAC

220-240 V



IP20

Ra >90

MAC 3

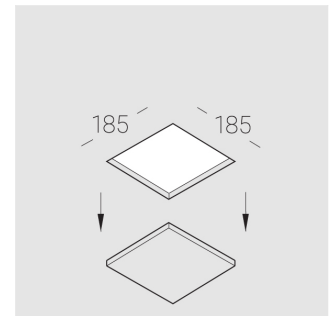
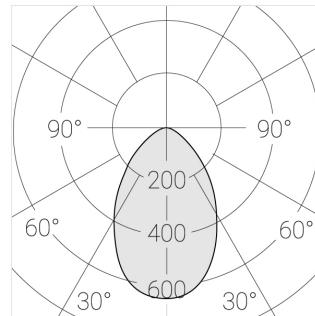
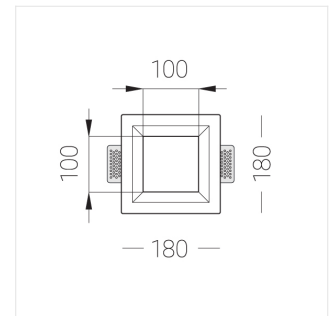
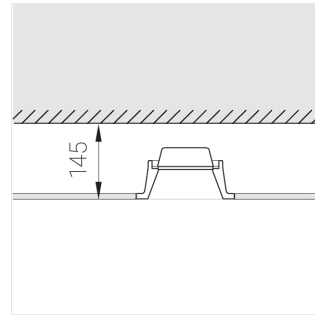
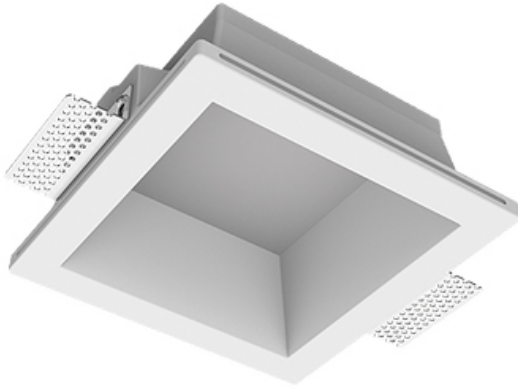

Complectation

Body	1
LED module	1
Control gear	1
Fastener	2
Screw x6	4
Screw self-tapping	2
Washer D5	4

Dimming by TRIAC accessible on request

The manufacturer reserves the right to change the configuration of the LED luminaire.

Specifications

Measurements:	180x180x96 mm
Net weight:	1.49 kg
Square	
Body:	Gypsum
Illuminant:	LED
Electrical safety class:	II
Degree of protection:	IP20
Rated power:	9.3 W
Luminaire luminous flux*:	755 lm
Light output*:	81.00 lm/w
Colorful temperature*:	4000 K
Color rendering index*:	Ra >90
Color temperature stability*:	MAC 3
cos *:	0.71
PRA:	LCAI 15W 150mA-400mA ECO slim

All parameters marked with * are calculated values.
Zenith uses tried and tested components from leading suppliers.
However, it is possible for some LED technology-related faults to occur over the life of the product.

** — the manufacturer reserves the right to replace the power supply with a similar one with the same characteristics.