

# Suspension luminaire



EVO Hang IN Black D400 64W 930 DA  
ze37001084

220-240 V



IP20

Ra >90

MAC 3

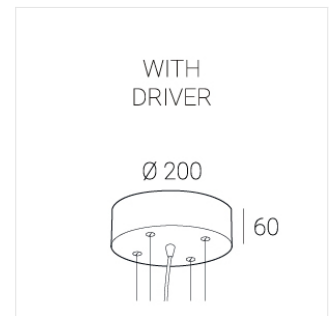
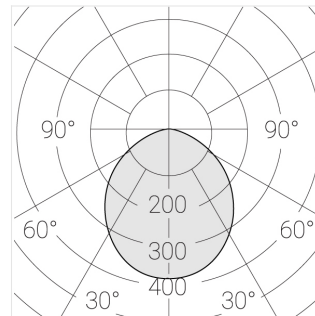
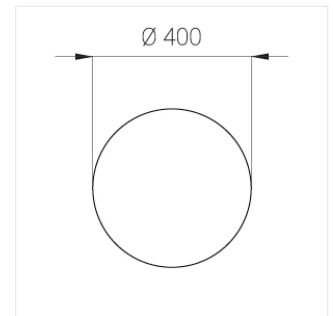
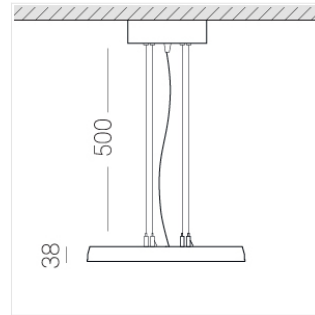

## Complectation

LED module	1
Ceiling attachment	1
Suspension cord	4
Cable	1

IN - power supply integrated into the ceiling cup, see installation manual.

The manufacturer reserves the right to change the configuration of the LED luminaire.

## Specifications

Measurements: D400x38; D160x25 mm

Round  
Body: Aluminum  
Illuminant: LED

Electrical safety class: I  
Degree of protection: IP20  
Rated power: 63.7 w  
Luminaire luminous flux\*: 6243 lm  
Light output\*: 98.00 lm/w  
Colorful temperature\*: 3000 K  
Color rendering index\*: Ra >90  
Color temperature stability\*: MAC 3  
cos \*: 0.97  
PRA: LCA 60W 900-1750mA one4all SR PRE

All parameters marked with \* are calculated values.  
Zenith uses tried and tested components from leading suppliers.  
However, it is possible for some LED technology-related faults to occur over the life of the product.

\*\* — the manufacturer reserves the right to replace the power supply with a similar one with the same characteristics.